

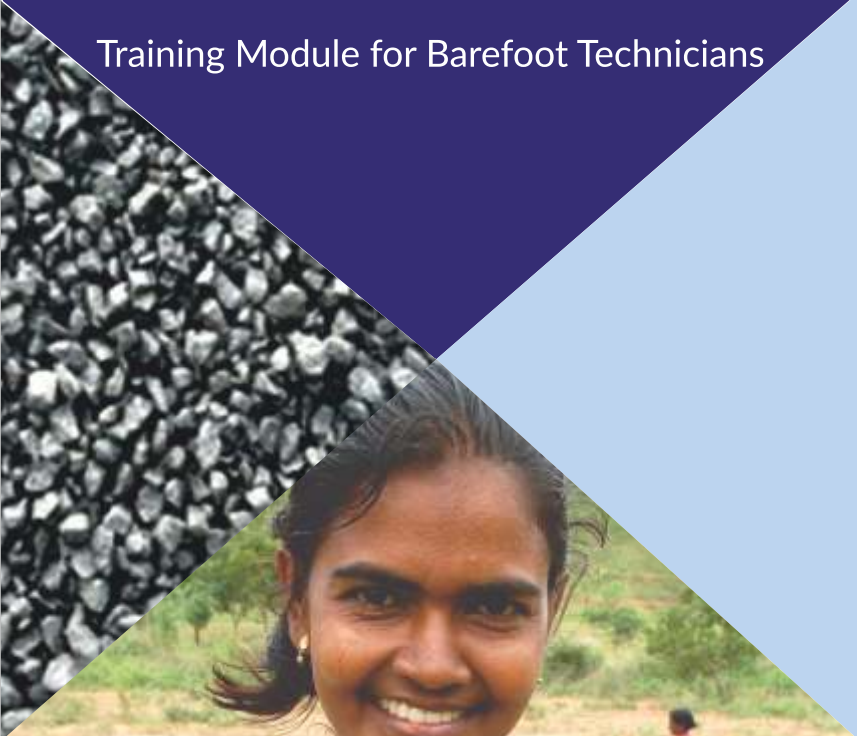

Construction Technology and Building Materials

Learning Unit 1.3

Training Module for Barefoot Technicians



Learning Unit 1.3

Construction Technology and Building Materials

Training Module for Barefoot Technicians

Technical Team for Preparation of the Modules for Barefoot Technicians

Mr. Mukesh C Gupta,
Senior Adviser (Consultant), ILO

Mr.A.Murali, IAS
CEO, SERP-Telangana

Mr.M.Siva Prasad,
Sr. Engineer, PRED, A.P.

Mr.Andreas Beush,
Senior Consultant, ILO - Switzerland

And a Team of following Resource Person contributed in developing the Training Manuals

Mr. V. Muralidhar, Office of Commissioner, Rural Development, Telangana

Mr. Sonal Kulshreshtha, GreenSync Solutions Pvt Ltd, Jhansi

Mr. Murlidhar Kharadia, Samaj Pragati Sahayog- Bagli

Mr. Dipak R. Jargela, Aga Khan Rural Support Program -Ahmadabad

Mr. A.Venkateshwar Rao, PRED-Hyderabad

Mr. Nirmal Kumar, PRED- Vijayawada

Mr. M.Bhakthar Vali Sab, Wassan -Hyderabad

Mr. Narendra Patel, Samaj Pragati Sahayog- Bagli

Mr. Rajesh Mit, Pradan- Jharkhand

Mr. Ishwar Babu Bairwa, Foundation for Ecological security- Jaipur

Mr. Vishal Gupta- Peoples Science Institute- Dehradun

M/s. T2 Information & Design LLP Team assistance in page setting, designing and printing

Mr. M. Gangadhar, Mr. Sudipta Kundu, and Mr. Chandan Sen Gupta contributed to preparation of sketches and drawings

The above Team worked under overall guidance and backstopping from:

Mr. R. Subrahmanyam IAS, Joint Secretary, MGNREGA, MoRD, New Delhi

Ms. Gayathri Kalia, C.O.O, DDU-GKY, MoRD, New Delhi

Mr. Rohit Chandra, DDU-GKY, MoRD, New Delhi

Mr. Manish Kumar, DDU-GKY, MoRD, New Delhi

Ms. Pannuda Boonpala, OIC, ILO New Delhi and DWT for South Asia

Ms. Mito Tsukamoto, Senior Adviser, DEVINVEST, ILO Geneva

Mr. Paul Comyn, Senior Specialist, Skills Development, ILO DWT for South Asia

Mr. Bjorn Johannessen, Senior Specialist, E.I.I, ILO ROAP, Bangkok

Ms. Anjana Chellani, Programme Officer, ILO, New Delhi

Acknowledgements

This module is the outcome of a team work and support from many persons and agencies. We are thankful to the Ministry of Rural Development (MoRD) and Deen Dayal Upadhyay – Grameen Kaushalya Yojana (DDU-GKY) and the ILO for entrusting this task of developing the training modules for the development and training of MGNREGS Barefoot Technicians.

The Team owes special gratitude to Mr. R.Subrahmanyam, IAS, Joint Secretary MGNREGA, MoRD and Ms. Gayathri Kalia, C.O.O DDU-GKY for providing encouragement and continuous guidance. We also wish to thank Ms. Pannuda Boonpala, Ms. Mito Tsukamoto, Mr. Paul Comyn, Mr. Bjorn Johannessen and Ms. Anjana Chellani of ILO for their continuous support and backstopping to the Team.

August, 2015

Technical Team

Table of Contents

Element 01: Introduction to Building Materials	5
Element 02: Soils, Sand and Stones	12
Element 03: Bricks	26
Element 04: Stone Aggregates	36
Element 05: Cement	44
Element 06: Cement Mortar and how to Prepare and how to Work with Mortar	53
Element 07: Cement Concrete Preparation and its use	69
Element 08: Foundations	89
Element 09: Superstructure with Stone /Brick Masonry	97
Element 10: Occupational Safety and Health standards for Workers on Site	111

Learning Unit 1.3

Construction Materials and Technology



Purpose of the learning Unit

This specific learning outcome *will enable you to list out and describe common construction material and work technology used in day to day work in implementation of MGNREGS.*

By the end of this Learning Unit, you will be able to:

- *List and describe the common construction materials used for rural infrastructure works under MGNREGS*
- *Identify and describe common construction technologies for rural infrastructure works carried out under MGNREGS*
- *Describe occupational health and safety standards to be followed at worksite.*



Elements of the learning Unit

This Learning Unit contains the following Learning Elements:

Element 1	:	Introduction to Building Materials
Element 2	:	Soils, Sand and Stones
Element 3	:	Bricks
Element 4	:	Stone Aggregates
Element 5	:	Cement
Element 6	:	Cement Mortar and how to Prepare and how to Work with Mortar
Element 7	:	Cement Concrete Preparation and its use
Element 8	:	Foundations
Element 9	:	Superstructure with Stone /Brick Masonry
Element 10	:	Occupational Safety and Health standards for Workers on Site

Element 1

Introduction to Building Materials

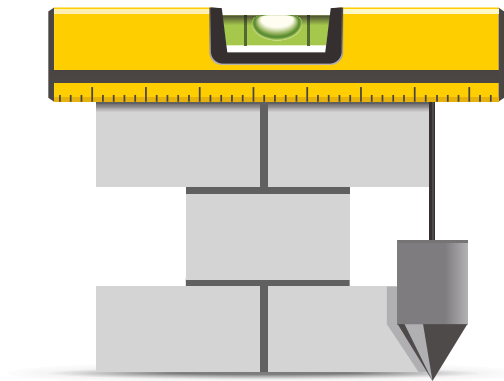



Learning Element Outcomes

This specific learning outcome will enable you to list out and describe the materials used in the works.

Summary

There are number of items (construction material) which are used in construction of buildings and other rural infrastructure. Some of them are naturally available and some of them are artificial. Many construction materials are used for same purpose but each of them has their own quality, durability and stability. We have to choose construction material according to purpose and resources available. This learning element will facilitate you to identify material for specific purpose and tools to be applied.





1. Construction Material

Definition: Articles, items, material supplied or consumed in the construction work

Types of Construction Materials

- Stone
- Brick
- Lime
- Cement
- Metal
- Ceramics
- Timber
- Sand
- Aggregates
- Mortar



<p>Sand</p>  A large, conical pile of light-colored sand is situated outdoors on a paved area. In the background, there are buildings, trees, and a person riding a motorcycle.	<p>Bricks</p>  A close-up view of a wall made of red bricks, showing the texture and color of the masonry.
<p>Stone</p>  A large pile of rough, greyish-brown stones is shown outdoors. Some stones are stacked in a low wall, while others are scattered on the ground.	 A large pile of smooth, grey, rectangular stones, likely used for construction or landscaping.
<p>Cement</p>  A large stack of grey cement bags, neatly piled and secured with yellow straps.	<p>Timber</p>  A large pile of cut logs and timber is stacked outdoors in front of a building with a corrugated metal roof.

Introduction to Building Materials



The construction material can be further divided in to two categories of first naturally available materials and second industry made materials.

Naturally available materials	Artificial or Industrial Materials	
<ul style="list-style-type: none">• Clay/Earth/Soil• Wood/Timber• Sand/Fine Aggregate• Rock	<ul style="list-style-type: none">• Cement• Bricks• Steel• Tiles• Ceramic	<ul style="list-style-type: none">• Paints and Varnishes• Glass• Plastic• Stone• Lime

Work Book

Exercise1: Identify the construction materials in the following Check dam



Ans _____



Exercise 2 Identify the building materials in the following buildings.



Ans _____

Exercise 3 Identify the building materials in the following buildings.



Ans _____

Element 2

Soils, Sand and Stones



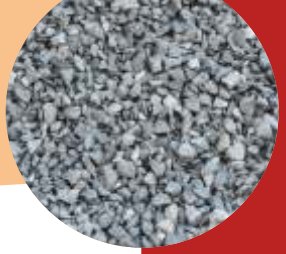

Learning Element Outcomes

This specific learning outcome will enable you to identify and describe the particular characteristics of soils, sand and stones and their suitability for construction works.

Summary

Soil, Sand and Stone are very important building material. One can know the suitability of these materials by doing simple test or by seeing them. Different types of Soils, Sand and Stones are explained in this element.

Soil

What is Soil?

Soil is a complex mixture of living organisms, organic matter, minerals, water and air. Take a handful of soil and look at it closely. You can see a mixture of different kinds of small particles some are visible some are not visible.



Types of Soil

Soil types are classified according to many factors on the basis of colour, productivity and texture. We need to understand soil by texture.

Types of Soil based on Texture



Sand



Silt



Clay



Definition of soil texture

Texture indicates the relative content of particles of various sizes, such as sand, silt and clay in the soil. Texture influences the ease with which soil can be worked, the amount of water and air it holds, and the rate at which water can enter and move through soil.

Field Test

To find the texture of a soil sample, first separate the fine earth, all particles less than 2 mm, from larger particles such as gravel, pebbles and small stones. Fine earth is a mixture of sand, silt and clay. You must be sure to use only fine earth to perform the following field tests.

How to find the approximate proportions of sand, silt and clay

This is a simple test which will give you a general idea of the proportions of sand, silt and clay present in the soil.

The bottle test

The bottle test

Step 1: Put 5 cm of soil in a bottle and fill it with water;

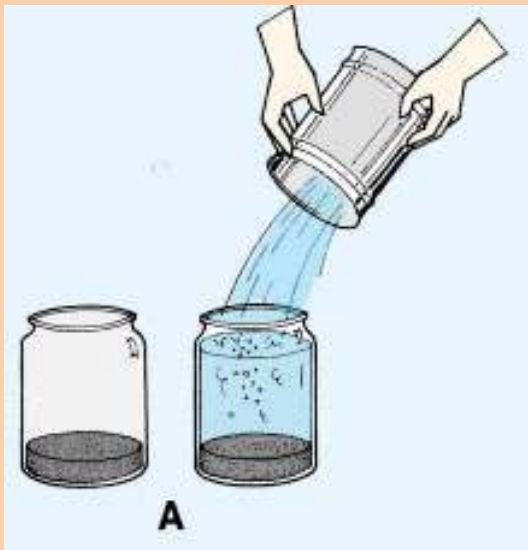

Step 2: Stir the water and soil well, put the bottle down, and do not touch it for an hour. At the end of an hour, the water will be cleared and you can see that the larger particles have settled;

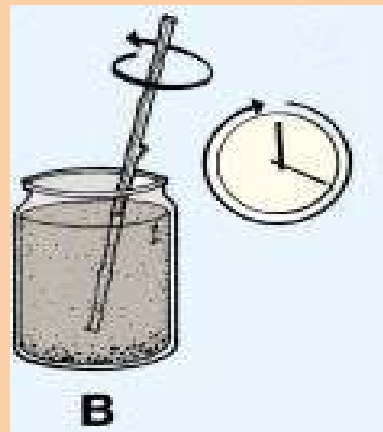

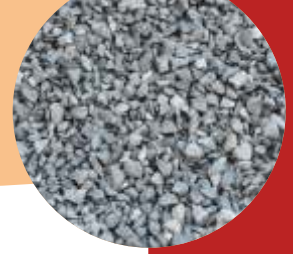

Step 3:

- At the bottom is a layer of sand;
- In the middle is a layer of silt;
- On the top is a layer of clay.
- If the water is still not clear, it is because some of the finest clay is still mixed with the water;
- On the surface of the water there may be bits of organic matter floating;

Step 4: Measure the depth of the sand, silt and clay and estimate the approximate proportion of each.

The manipulative test

The manipulative test gives you a better idea of the soil texture. This test must be performed exactly in the sequence described below to be successful; each step requires progressively more silt and more clay.

	<ul style="list-style-type: none"> ○ Take a handful of soil and wet it so that it begins to stick together, but without sticking to your hand;
	<ul style="list-style-type: none"> ○ Roll the soil sample into a ball of about 3 cm in diameter;
	<ul style="list-style-type: none"> ○ Put the ball down...
	<ul style="list-style-type: none"> ○ If it falls apart, it is sand; ○ If it sticks together, go on to the next step. ○ Roll the ball into a sausage shape, 6-7 cm long
	<ul style="list-style-type: none"> ○ If it does not remain in this form, it is loamy sand; ○ If it remains in this shape, go on to the next step. ○ Continue to roll the sausage until it reaches 15-16 cm long



- If it does not remain in this shape, it is sandy loam;
- If it remains in this shape, go on to the next step.
- Try to bend the sausage into a half circle



- If you cannot, it is loam;
- If you can, go on to the next step.
- Continue to bend the sausage to form a full circle ...
- If you cannot, it is heavy loam;
- If you can, with slight cracks in the sausage, it is light clay;
- If you can, with no cracks in the sausage, it is clay.

Sand

Classification of sand and aggregates

Material retained on a 4.75mm IS (Indian Standard) sieve is classified as coarse aggregate, and below that size as fine aggregate or sand. The material passing a 75-micron IS sieve is generally considered to be clay, fine silt or fine dust in an aggregate.

Sand, which contains 90% of particles of size greater than 0.06mm and less than 0.2mm, is fine sand.

Sand, which contains 90% of particles of size greater than 0.6mm and less than 2 mm is coarse sand.

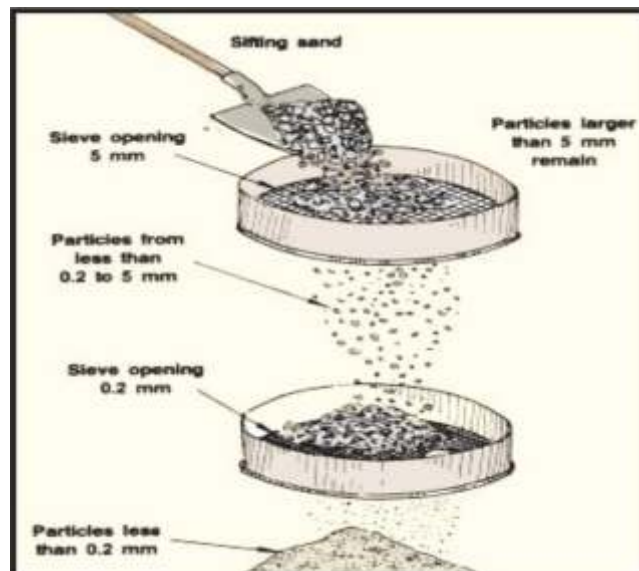

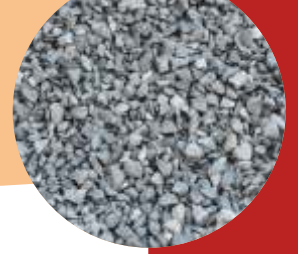

Types of Sand

1. Natural sand
2. Artificial sand
1. Natural sand
2. Pit sand: This is radish orange in colour usually sharp, angular and free from salts and mostly used in concretes.
3. River sand: This is whitish grey in colour and is the best sand for construction activity. Widely used for constructions.
4. Sea/Beach sand: This contains salt by nature and tends to absorb moisture from atmosphere and bring stickiness to the building. Hence not suitable for constructions.
5. Artificial sand

This sand is manufactured by crushing either granite or basalt rock using 3 stage crushing process. This is also known as robo-sand. This is not widely used due to high cost but now used in cities. This can be used in construction



Properties of good sand

- It should be clean and coarse
- It should be free from any organic or vegetable matter.
- Maximum permissible clay content is 8% in sand
- It should be chemically inert.
- It should contain sharp, angular grains.
- It should mix with binding material easily
- It should not contain salts which attract moisture from the atmosphere



Sand storage

The sand should be stored preferably under shade and sufficiently protected, from animal agricultural and vegetative waste.

Testing the sand quality

There are two types of sand quality-testing methods, namely:

A. Visible test

Check the sand for impurities such as organic materials (mud, leaves, roots etc.) remove them before using the sand.

B. Clay and silt content test

The clay and silt content test can be done in two ways:

a. Hand test

The sand sample is rubbed between damp hands. Clean sand will leave hands only slightly stained. If the hands stay dirty, it indicates the presence of too much silt or clay.

b. Bottle test

- c. Obtain a clear, wide-mouthed glass jar.
- d. Fill the bottom of the jar with sand 5 cm deep.
- e. Add clean water until the jar is three-quarters full.
- f. Add, if available, two teaspoons of common table salt per litre of water.
- g. Close the jar and shake it vigorously for one minute.
- h. Let it stand for three hours.
- i. Check the sand surface. If silt is present, it will form a layer on top of the sand.
- j. If there are more than 3 mm of silt, the sand must be washed.

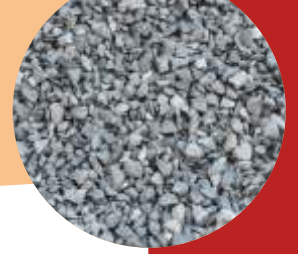

DO

Dirty sand should never be used in masonry because it will reduce the adhesive value of mortar considerably.

Uses of sand

- Sand is used in various construction activities like masonry work, plaster work, flooring and concrete work. The particle size of the sand for mortar and concrete has to be in the range of 0.15mm to 2.36mm
- Sand is used in cement mortar, plain cement concrete, reinforced cement concrete and pre-stressed concrete as key ingredient in building construction

Stone

Introduction

In the early days man lived in caves and huts with broken trees and leaves. Later on stones were used for building better huts. In construction of temples, stones were used in foundation, walls, roof slabs and pavements.

Uses of Stones

Stone are largely used in many permanent engineering works on account of the durability and the least expensive upkeep of such structures. The principal uses of stone in construction are:



- Materials for foundation and walling of buildings, dams, bridges, etc.
- Materials for road construction and concrete making in the form of broken or crushed stones.
- Thin slabs for paving.
- Ornamental works.
- Roofing tiles in the form of slates.
- Lime stone for manufacture of cement.
- Bandage for flooring and covering road surface.

Quality tests

There are several tests possible to define the quality of a stone. However, in the field there are basically three tests where one can define the suitable quality of a stone.

Hammer test

Take a hammer and strike it for its sound. A clear, hard ringing sound indicates that the stone is of good quality and has no major defect such as holes or cracks.

Visible test

Check the stone for any defects such as cracks, patches with soft materials, discoloring etc.

Porosity or absorption test



Weight a stone of reasonable size and place it for 24 hrs into a water-bucket. A good building stone should not absorb more than 5% of its weight of water after 24hrs immersion.

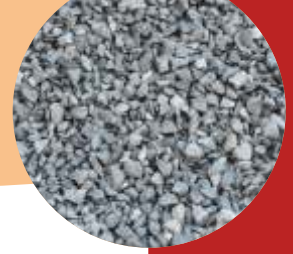

tests possible to define the quality of a stone. However, in the field there are basically three tests where one can define the suitable quality of a stone.

check the stone for its sound. A clear, hard ringing sound indicates that the stone is of good quality and has no major defect such as holes or cracks.



	<ul style="list-style-type: none">○ Correlate well with ecosystem processes○ Integrate soil physical, chemical, and biological properties & processes○ Be accessible to many users○ Be sensitive to management & climate
Soil	
	<ul style="list-style-type: none">○ It should be clean and coarse○ It should be free from any organic or vegetable matter.○ Maximum permissible clay content is 8% in sand○ It should be chemically inert.○ It should contain sharp, angular grains.○ It should mix with binding material easily○ It should not contain salts which absorbs moisture from the atmosphere
Sand	<ul style="list-style-type: none">○ It should be strong and durable.
	<ul style="list-style-type: none">○ Hard, Rough, Dry, Heavy, Smooth,○ Resists to Water, Heat, Cold, Weathering○ Has no major defect such as holes or cracks.○ Hard ringing sound
Stone	



Work Book

Q 1: Collect samples of all types of soils, sand and stones (with name) in your area identify it and store in plastic bag for live demo.

Ans: _____

Q 2: Explain the type of soil based on its texture.

Ans: _____

Q 3: How do you estimate the proportion of sand silt and clay of soil. Explain the process step by step.

Ans: _____

Q 4: What are the different sources of sand?

Ans: _____

Q 5: Write the qualities of good sand.

Ans: _____

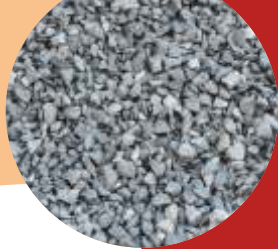

Q 6: Write the name of structures you have seen made up of stone.

Ans: _____

Class room Notes:



Element 3

Bricks





Learning Element Outcomes

This specific learning outcome will enable you to identify and describe the particular characteristics of bricks and their suitability in construction works.

Summary

Bricks are widely used for construction of walls. Good bricks with high quality make structure durable and look beautiful. One should know the appropriate size and quality of bricks to be used which are explained in this element.

Introduction:

Brick is an old building material since very long time. Brick is used in construction of the building because of its good load bearing capacity, long life, and strength. Bricks are made up of good clay and molded in rectangular shape of uniform size then dried and burned. As bricks are in uniform size they can be beautifully laid in masonry work. It can also be carried to top of the building due to its low weight.



Definition

Bricks are obtained by molding clay in rectangular blocks, then drying and burning them. In place where stones are not easily available, bricks are used in construction. Bricks are preferred because of their durability, strength, reliability, low cost etc.

Size and Weight of Bricks

Bricks are prepared in various sizes. Custom in the locality is the governing factor for deciding the size of a brick. Such bricks which are not standardized are known as the traditional bricks.

BIS has recommended the bricks of uniform size. Such bricks are known as the modular bricks.



- Standard / Modular : Size : 190 mm x 90 mm x 90 mm and 190 mm x 90 mm x 40 mm
- Conventional / Traditional bricks : Size 230 mm x 110 mm x 70 mm
- The average weight of a brick will be about 3.00 to 3.50 kg.

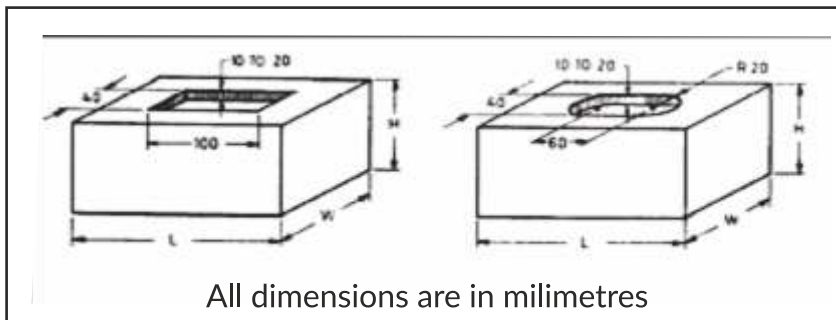





Classification of Bricks

1. Un-burnt bricks
2. Burnt Bricks

First type of brick may be burnt in sun light, (or) when burnt in kiln it may not be burnt well. The unburnt bricks are used to construct temporary structures.

Second type of bricks is well burnt bricks which can be used for permanent structures. Well burnt bricks are further classified as following.



Type	Quality
	These bricks are table molded and burnt in kilns. It should be thoroughly burnt (without being vitrified) and have rectangular plane surfaces with parallel sides and sharp straight right-angled edges. It should have firm compact and uniform texture. First class bricks are mainly used for face-work or superior work of structure. The structure constructed with these bricks doesn't need plastering.
First Class Bricks	
	These bricks are ground molded and burnt in kilns and generally used to meet the requirements of first class bricks except that these may be slightly chipped, distorted or may have surface cracks.
Second Class Bricks	
	These bricks are ground molded and burnt in clamps. They are not hard and have rough surfaces with irregular distorted edges. These bricks are used in unimportant and temporary structures and in places where rainfall is less. The structures constructed with these bricks need plastering.
Third Class Bricks	
	These bricks are over burnt bricks with irregular shapes and used as aggregate in foundations, floors etc. They are stronger due to over burning.
Fourth Class Bricks	

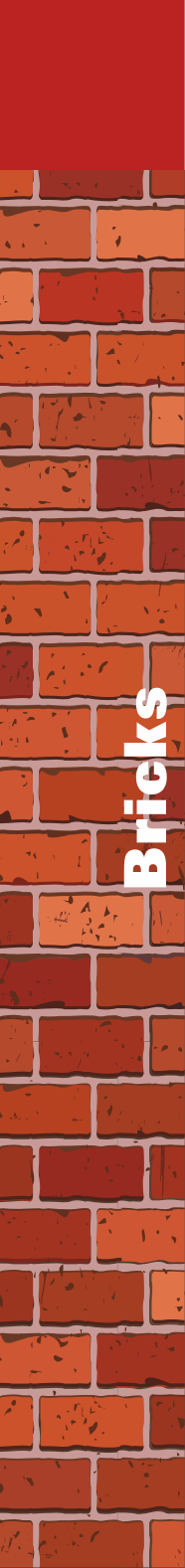

Properties of Good Bricks

Good bricks are used for the construction of important structures. They should possess following qualities.

- Bricks should be table-mounted, well-burnt in kilns, copper coloured, free from cracks and with sharp and square edges.
- Bricks should be uniform in shape and of standard size.
- Bricks should give clear ringing sound when struck with each other.
- Bricks when broken should show homogeneous and compact structure free from voids.
- Brick should not absorb water more than 15 percent of weight for first class bricks and 15 to 20 percent by weight for second class bricks, when soaked in water for 24 hrs.
- Bricks should be sufficiently hard. No impression should be left on brick surface, when scratched with finger nail.
- Bricks should not break into pieces when dropped flat on hard ground from a height of one meter.
- Bricks should have low thermal conductivity.
- Bricks when soaked in water for 24 hours should not show deposits of white salts when dried in shade.
- The Compressive Strength of brick shall not be less than 55 kg/cm²

Uses of Bricks

- Bricks are used in wall construction of building
- Bats of brick are used in concrete in foundation work



Quality of bricks

Description	Class-1	Class-2	Class-3
Water absorption	Max 15%	Max 15to20%	Max 20%
Compressive Strength	Above 250 kg/cm2	Up to 200 kg/cm2	Up to 125 kg/cm2

Soaked bricks: The strength of brick decreases by about 25% when soaked in water

Structure: Brick when broken should be homogeneous in structure, compact and free from holes, cracks, fissures, air bubbles, lumps, pebbles, stones and lime particles.

Shape and size: The brick should be rectangular with straight and sharp edges. All bricks should have the same dimensions and no broken corners or edges. The size of the bricks varies slightly from region to region in India.

Soundness: The quality of brick is said to be good if there is a clear ringing metallic sound when two bricks are struck together.

Fall test: A brick should not break when dropped flat on hard ground from a height of about one meter.

Scratch test: A good burned brick has surface so hard that the fingernail cannot scratch it

Remember

- Don't use over burnt (coloured black or red or both mixed) for construction of wall.
- Don't use brick having significant presence of sand.
- Drop test from 1 Meter height from ground will tell you the strength quality of bricks.



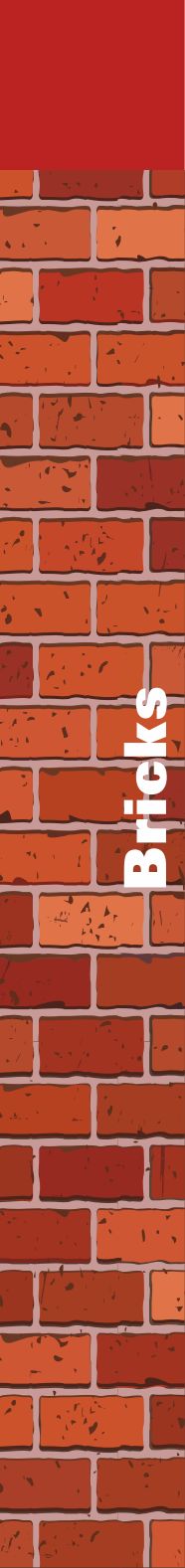

Work Book

Q1: Collects sample of all type of Bricks in your area and identify it in terms of its strength, colour, size etc.

Ans: _____

Q 2: Write the name of structures in your area where bricks are used.

Ans: _____

Q:3 What are the properties of good bricks?

Ans: _____



Field Notes:

A series of horizontal dashed lines for taking field notes.



Bricks

Element 4

Stone Aggregates





Learning Element Outcomes

This specific learning outcome will enable you to identify and describe the particular characteristics of stone aggregate and its suitability in construction works.

Summary

Stone and Stone aggregate are very important building material required to attain strength and durability of the structure. In this element types of stone and simple quality test of stone are covered.

Coarse Aggregates

Aggregate most of which is retained on 4.75 mm IS Sieve and contains only as much fine material as is permitted in IS 383 for various sizes and grading is known as coarse aggregate.

Coarse aggregate shall be specified as stone aggregate, gravel or brick aggregate and it should be obtained from approved/ authorized sources/quarries.

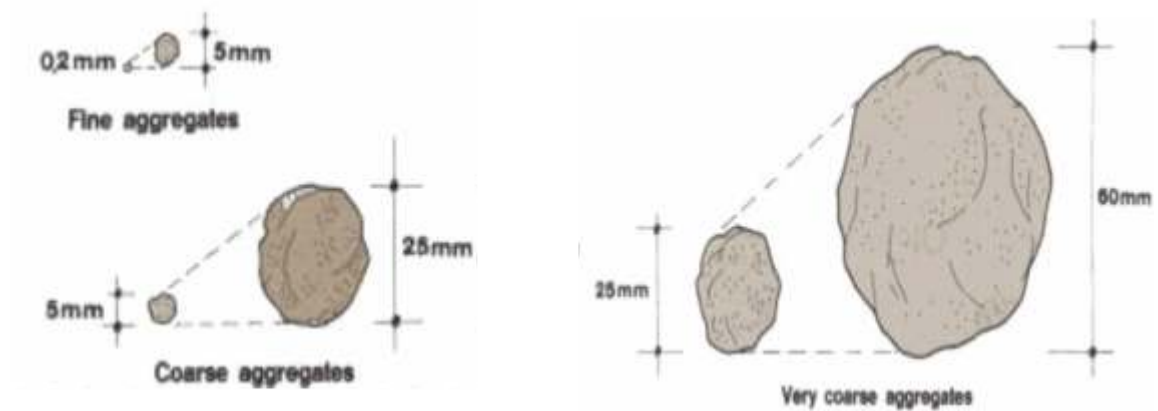



Stone Aggregate



- It should consist of naturally occurring (uncrushed, crushed or broken) stones.
- It shall be hard, strong, dense, durable and clean.
- It shall be free from organic matters, adherent coating, alkali, vegetable matter and other deleterious substances.
- It should be roughly cubical in shape. Flaky and elongated pieces shall be avoided.

Gravel



- It should consist of naturally occurring (uncrushed, crushed or broken) river bed shingle or pit gravel.
- It should be hard and clean.
- It should be free from flat particles of shale or similar laminated material, clay, silt, loam, adherent coating, alkali, vegetable matter and other deleterious substances.
- Pit gravel should be washed if it contains soil materials adhering to it.

Brick Aggregate



- Brick aggregate should be obtained by breaking well burnt or over burnt dense brick/ brick bats. It should be homogeneous in texture, roughly cubical in shape and clean.
- It should be free from unburnt clay particles. Soluble salt, silt, adherent coating of soil, vegetable matter and other deleterious substances. Such aggregate should not contain more than one percent of sulphates and should not absorb more than 10% of their own mass of water, when used in cement concrete.



Size

Stone aggregate and gravel can be either graded or single sized as specified. Nominal sizes of graded stone aggregate or gravel shall be 63,40, 20,16, or 12.5 mm as specified.

Properties of Aggregates

- Insoluble in water.
- Moderate weight.
- Strong and durable.
- Resistance to scratches.
- Resistance to erosion and decay.

Uses of aggregates

- Fine aggregates are used to prepare cement mortar, lime mortar and cement concrete.
- Course aggregates are used to prepare cement concrete bituminous pavement, rigid pavement etc.
- They are used in construction of beams, columns, slab, lintel etc.,





Work Book:

Q 1: Collects sample of all types of aggregate (with name) in your locality and identify it and store in plastic bag for live demo in the class.

Ans: _____

Q 2: What are qualities of good aggregate?

Ans: _____

Q 3: Write the size of gravels used in construction.

Ans: _____

Element 5

Cement





Learning Element Outcomes

This specific learning outcome will enable you to identify and describe the particular characteristics of cement, its use in construction works and how to handle it.

Summary

Cement is the most important material in all solid structure like masonry, concrete, reinforced cement concrete, plastering etc. Handling of cement, storage of cement and type of cement are explained in this learning element.

Introduction

Cement is a mixture of 60 to 67% lime, 17 to 25% silica and 3 to 8% alumina, which are intimately mixed together with water to form slurry, which is subsequently heated, dried, and grounded to a very fine powder. A small proportion of gypsum is added before grinding in order to control the rate of setting.

Setting/Hardening

The terms setting and hardening have different meanings.

- Setting is the process which changes a fluid concrete to a solid concrete.
- Hardening is the process by which the weak set concrete attains strength over a period of few days.

Hydration of cement

When water is added to cement, it hydrates and during the chemical reactions which take place while the cement is setting, an increase in temperature occurs and a considerable quantity of heat is generated during this process which is known as hydration



Type and quality

You should use Ordinary Portland cement (OPC), which is standard and most widely available, for all type of works taken in MGNREGS. The cement used should be any of the standard grades and the type selected should be appropriate for the intended use. Different types of cement should not be mixed together.

The comprehensive strength of cements for each grade are as follows



Sample age at testing	Strength in Kg/Cm ² shall be not less than for		
	33 grade	43 grade	53 grade
3 Days	160	230	270
7 Days	220	330	370
28 Days	330	430	530

Required Properties and Setting time

- Grey color.
- Initial setting time of cement should not be less than 30 minutes.
- Final setting time should not be more than 10 hours.



Cement storage

Remember Cement Storage

1) Cement should be stored at the work site in a building or a shed which is dry, leak-proof as well as moisture-proof.

2) Cement should be stored and stacked in bags, kept free from the possibility of any dampness or moisture coming in contact with them. Cement bags should be stacked off the floor on wooden planks in such a way as to keep about 150 mm to 200 mm clear above the floor. The floor may comprise of lean cement concrete or two layers of dry bricks laid on well consolidated earth. A space of 600 mm minimum should be left between the exterior walls and the stacks (see Fig. 1).

3) The height of stack should not be more than 10 bags to prevent the possibility of lumping up under pressure. The width of the stack should be not more than four bags. Cement

bags should be stacked in a manner to facilitate their removal and use in the order in which they are received; a lable showing date of receipt of cement should be put on each stack to know the age of cement.

4) For extra safety during the monsoon, or when it is expected to store for an unusually long period, the stack should be completely enclosed by a waterproofing membrane such as polyethylene, which should close on the top of the stack.

5) Cement in gunny bags, paper bags and polyethylene bags should be stored separately

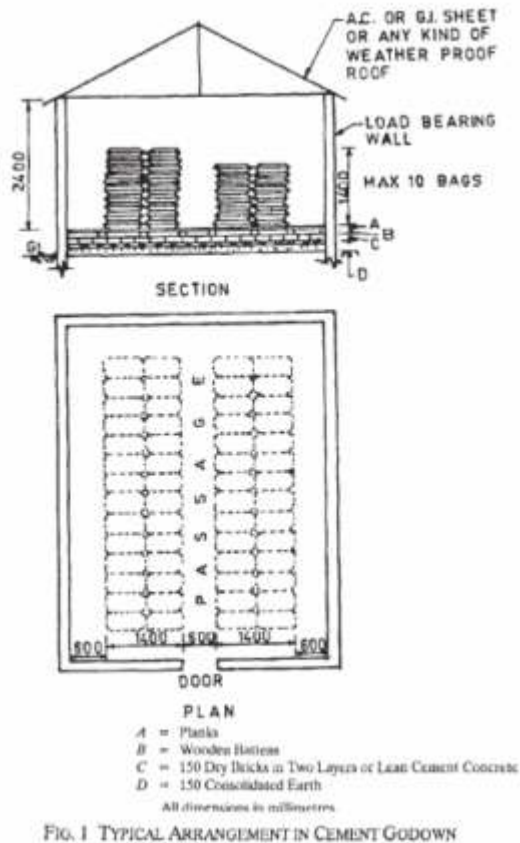

Remember

- Ordinary Portland cement, which has been stored for over six months, should not be used for masonry work.



The average reduction of strength in a 1:2:4 mix as a result of storage is

Fresh cement	Strength 100%
Cement after 3 months	strength reduced by 20%
Cement after 6 months	strength reduced by 30%
Cement after 12 months	strength reduced by 40%
Cement after 24 months	strength reduced by 50%

Testing the cement quality

The indication of damaged cement is given by the presence of large lumps of set cement. These lumps of set cement should not be used, not even if screened again.

The freshness of cement can be tested as per following description:

Lump test: Check the cement for any small or large lumps. Remove them

Rubbing test: When cement is rubbed between fingers and thumb it should feel like a smooth powder such as flour.

Setting test: If you are uncertain about your cement quality you can make a simple setting test. Make a stiff paste of neat cement and water and form it into a cake about 75 mm diameter and 12 to 15 mm thick. The cake should commence to set in about 30 to 60 minutes. In 18 to 24 hours the cake should have hardened sufficiently so that it does not effortlessly scratch the surface with a thumbnail.



Work Book:

Q 1:Cement is mostly used for works taken under MGNREGS.

Q 2 :Cement should not be used after.....months.

Q 3: What precautions should be taken in the storage of cement at work site.

Ans: _____

Q4: How do you test the Cement quality?

Ans: _____

Cement

Element 6

Cement Mortar





Learning Element Outcomes

This specific learning outcome will enable you to describe the particular characteristics of cement mortar, its use in construction works, how to mix it and how to work .

Summary

Cement mortar is used in construction of walls, plastering, other works like flooring etc. The quality of cement mortar depends on the quality of sand and quality of water and proportion of cement and sand. To achieve best quality of mortar certain important information and processes are explained in this learning element.

What is mortar?



Mortar may be defined as a material composed of fine aggregate and cement, which forms a hardened mass after mixing with water. It is used in beds and side joints of masonry work, in order to bind the stones, bricks or blocks together and distribute the pressure throughout the block-work. Mortar is a paste prepared by adding required quantity of water to a mixture of binding material like cement or lime with sand. The durability strength and quality of mortar mainly depend on the quantity and quality of the matrix. The combined effect of the two components of mortar is able to bind the bricks or stone firmly.

Mortar is further used for plastering work, pointing work, flooring and topping work.

Good mortar used for masonry consists of cement, sand and water in the correct proportions. When the materials are freshly mixed, mortars have a plastic consistency, which could be easily worked with trowels to fill the joints in masonry or to render the surfaces of walls by plastering etc. By the virtue of the setting properties of the binding material used (cement, lime) they set and become hard subsequently.

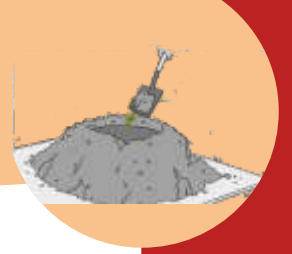

Properties of Mortar

- It should have good adhesion with bricks, stones etc.
- It should offer good resistance to the penetration of rain water.
- It should be in position to maintain its original appearance for sufficiently long periods.
- It should be easily workable.
- It should not adversely affect the building on which it is to be used.
- It should set and harden quickly, so that speed of construction work may be maintained.
- It should not crack in joints.

Type of mortars

Generally there are three common types of mortars in use for masonry and plastering work, namely

1. Cement mortar
2. Lime mortar
3. Cement - lime mortar

1. Cement mortar

Cement mortar is nowadays most commonly used mortar for brick as well as stones or concrete block masonry work. It provides high strength properties. Mix proportion varies according to requirements of the masonry structure.



2. Lime mortar

This is a mixture of quicklime (burnt limestone) and sand in the proportion of 1 part lime and 3 parts sand, in addition to water. Lime mortar was once the principal material used for bedding and jointing bricks and stones. Now it is used less frequently as it develops strength very slow and is not easily available in the market.





3. Cement – lime mortar

This is the most usual general-purpose mortar comprising 1 part cement 2 parts lime and 9 parts sand. The addition of lime improves the workability and makes it easier to use. Cement - lime mortar is mainly used for internal work.

Precautions in using mortar

Following precautions need to be taken while making use of mortar:

- After preparation, mortar should be consumed as early as possible. The cement mortar should be consumed within 30 minutes after adding water. For this reason, it is advisable not to prepare cement mortar of more than one bag of cement at a time.
- The setting action of mortar is affected by the presence of frost. It is therefore advisable not to work in frosty weather or to execute it with cement mortar which will set before it tries to freeze.
- The presence of water in mortar is essential to cause its setting action. Hence the building units should be soaked in water before mortar is applied.
- The construction work carried out by mortar should be kept damp or wet by sprinkling water to avoid rapid drying of mortar.
- The mortar should not contain excess water and should be as stiff to be convenient to use.

Water

- Water used for mixing and curing should be clean and free from injurious quantities of alkalis, acids, oils, salts, sugar, organic materials, vegetable growth or other substance that may be deleterious to bricks, stone, concrete or steel. Potable water is generally considered satisfactory for mixing. The PH value of water should be not less than 6.
- The physical and chemical properties of ground water should be tested along with soil investigation and if the water is not found conforming to the standards then such water should not be used for mortars.
- Water found satisfactory for mixing is also suitable for curing. However, water used for curing should not produce any objectionable stain or unsightly deposit on the surface.
- Sea water or salty water should not be used for concrete mixing or curing any cement work

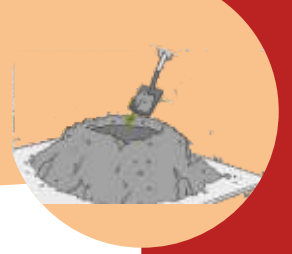

Mortar sand granulation

The sand used for every kind of mortar must be clean and free from clay and other organic matters.

For getting a proper mortar, the granulation of the sand needs to be correct. Sand without fines (below 0.5mm) gives a harsh mortar with a low compressive strength and a bad workability. Cement mortar gives the best result when the sand comprises of the following:

0 – 0.5 mm (60% 0-0.2 mm)	1 part
0.5 – 2 mm	1 part
2 – 4 mm	1 part

Mortar Mixing Method

1. Weight method

Mortar mixtures are also expressed in kg of cement per 1 m^3 of cement mortar. For example PC 250 means that 250 kg of Portland Cement (PC), approx. 1000 liters of sand and 120 liters of water are used to obtain about

1 m^3 mortar. This method is mainly used for large constructions in cities for bridges, hotel and shopping complexes etc. (1 Bag Cement = 50 Kg Cement)







2. Volumetric method

Usually at small and rural construction sites, volume batching method which is more practical is used. The volumetric method is a very appropriate way to mix raw materials. Special care must be given to ensure that the workers measure each time the same volume.



Preparing a good mortar

To prepare a good mortar, carefully proceed as follows:

 <p>Mixing sheet</p>	<ul style="list-style-type: none">○ Prepare a clean mixing area, for example a metal sheet or a watertight wooden platform. As a rough guide, a 1-m² area is enough for 50 kg of mix.
 <p>Wet sand if dry Measure sand</p>	<ul style="list-style-type: none">○ Measure the quantity of sand required. If it is very dry, wet it a little before measuring.
 <p>Spread sand</p>	<ul style="list-style-type: none">○ Spread the sand over the mixing area.
 <p>Measure cement</p>	<ul style="list-style-type: none">○ Measure the quantity of cement required
 <p>Spread cement on top of sand</p>	<ul style="list-style-type: none">○ Spread the cement on top of the sand.
 <p>Mix sand and cement</p>	<ul style="list-style-type: none">○ Mix the sand and cement together thoroughly, until the mix has a homogeneous colour. Be sure to mix in the bottom and side materials.

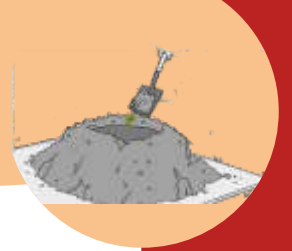

	<ul style="list-style-type: none"> ○ Form a hollow in the middle, slowly add little water in the hole and moisten part of the mix. Work with water by carefully moving the dry mix in toward the hollow. Be careful not to let water run away.
	<ul style="list-style-type: none"> ○ Repeat adding water slowly until the whole mix is moistened. Continue mixing thoroughly, add just enough water to obtain a plastic consistency. The mortar should have a firm, smooth appearance. You should be able to make a clean slice into it with a trowel or shovel. It should sit on a trowel cleanly and firmly without loss of water and should spread smoothly.

Categorization of mortars and its mix ratio

Mortars are categorized in mainly three groups, namely:

Remember

- Do not use too much water in the mortar

Group 1

Highly stressed masonry incorporating height strength structural units as used in multistory load bearing buildings.

Group 1 batching

Cement	Sand
1	4
Basket	Basket

Group 2

Normal load bearing applications such as external house walls, parapets, and balustrades, retaining structures, freestanding garden walls and other walls exposed to severe dampness.

Group 2 batching







Cement	Sand
1	6
Basket	Basket



Group 3

Lightly stressed non-structural walls Group 3 batching

Cement	Sand
1	8
Basket	Basket

Group	Cement Bucket	Sand Buckets
Group-1		
Group-2		
Group-3		

Using a cement mortar

The mortar should be used immediately after preparation. Mortar should never be used after it has started to set. Avoid using mortar which got dropped from the working area.

The surfaces to come in contact with the mortar should be clean and rough. It is essential to wet them well before applying the mortar, for example by soaking bricks in water for 30 minutes or wetting bricks with water and wetting cement blocks, so that they do not absorb the water from the mortar and reduce its strength. If you are working in dry conditions, be careful to keep the bricks or cement blocks wet.

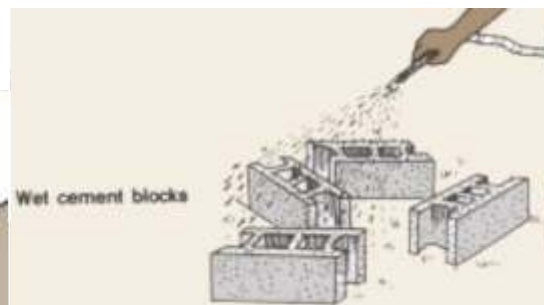
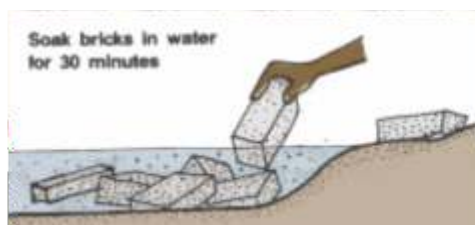

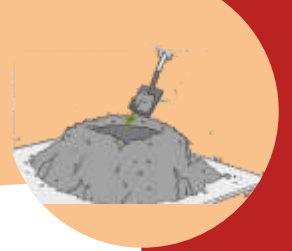

Protect mortar from the sun's heat and from drying wind until it hardens to the point where its surface cannot be scratched with a fingernail. At this stage, setting is complete enough for normal requirements. In hot, dry conditions, you can protect the setting mortar by covering the areas concerned with wet sacking, or alternatively, by using a fine spray of water. However, be careful not to wash out the mortar.

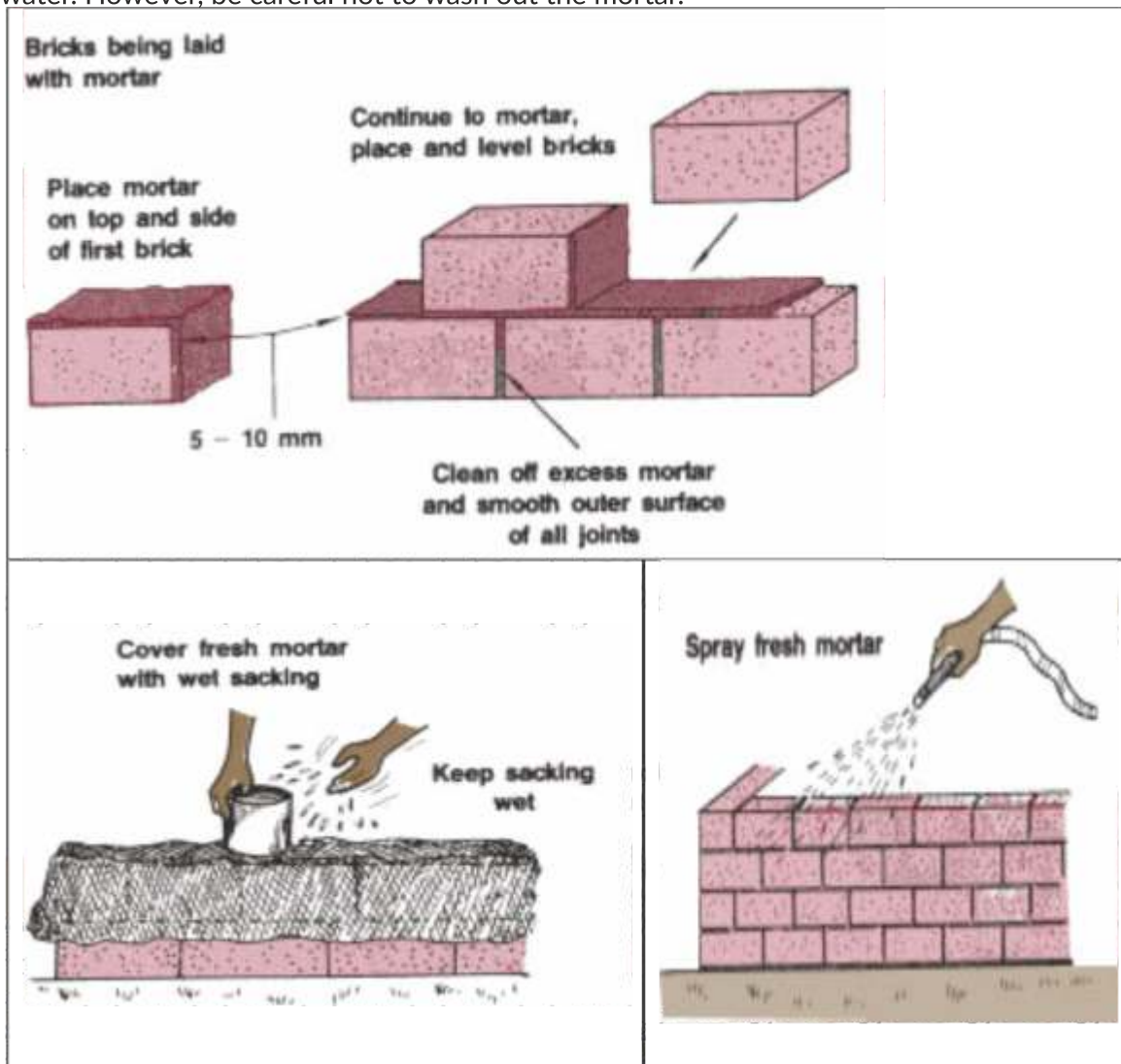

Dos:

- ✓ Use always clean sand for mortar.



Why?

Contaminated sand with roots, leaves, plastic parts, saw dust, animal and human excreta etc will not bind with cement, hence it weakens the mortar. Also sand with high percentage of clay or silt will weaken the mortar, because clay or silt contains too many fines that need to be covered by cement for proper binding, hence, the mortar becomes weak.

- ✓ Always use fresh and lump free cement for mortar.

Why?

Old cement loses its strength. For example cement that has been stored for more than 6 months loses 30% strength than fresh cement. For good masonry work, strength is important as it influences the overall building quality and durability.

Improperly stored cement results in loss of quality

- ✓ Always mix the dry ingredients (sand & cement) together before adding water.

Why?

Wet sand particles have the tendency to stick together and therefore hinder cement to cover all particles. This results in a non-uniform mix that reduces the mortar quality, because each sand particle should ideally be fully covered with cement

Further adding water together with sand and cement in one go makes mixing mortar extremely difficult for the laborers.

- ✓ Always protect the mortar-mixing place from wind, rain and sunshine.

Why?

Wind and sunshine make water evaporate from the mortar and thus accelerate the hardening process before it is put to use. This makes the mortar useless for any purpose. Rain makes adding of water and thus mortar becomes liquidly and loses its workability.

Don'ts:

- ✗ Do not use or re-use mortar that has already hardened. As cement mortar sets relatively quick (approx. 30 minutes), it should never be mixed in huge quantities.

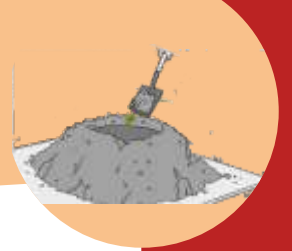

Why?

In hardened mortar, the hydration process of the cement has started already and re-mixing it destroy the bond between cement and sand. This bond cannot regain strength again by simply adding fresh water to the mortar.



Machine Mix



Hand Mix



Workability of Concrete



Cohesiveness of Concrete

Cement Mortar



Worksheets

Practical Exercises:

Q 1: Go to a work site and do practical in mortar mixing and write your experience.

Ans: _____

Q 2: What are the properties of good mortar?

Ans: _____

Q 3: Write the name of mortar commonly used.

Ans: _____

Q 4: What are the general precautions in using mortar?

Ans: _____

Q 5: How do you prepare a good quality mortar?

Ans: _____

Q6: Write the ratio of mortar commonly used.

Ans: _____

Element 7

Cement Concrete

Preparation and its use





Learning Element Outcomes

This specific learning outcome will enable you to describe the particular characteristics of cement concrete, its use in construction works, how to mix it and how to work with.

Summary

Concrete is used in construction of foundation, beams, columns and slab of building, check dams, spillways and cross drainage structures. Strength and durability of framed structure depends on the quality of concrete. This element will explain the components of concrete and there different ratio/ mixtures and their use.

What is Concrete?

In its simplest form, concrete is a mixture of cement paste and aggregates. The cement paste, composed of portland cement and water, coats the surface of the fine and coarse aggregates through a chemical reaction called hydration, the paste hardens and gains strength to form the rock-like mass known as concrete. Within this process lies the key to a remarkable trait of concrete: it's plastic and malleability when newly mixed, strong and durable when it is hardened. These qualities explain why one





material, concrete, can build skyscrapers, bridges, sidewalks and highways, houses and dams. The key to achieving a strong, durable concrete rests in the careful proportioning and mixing of the ingredients. A concrete mix that does not have enough paste to fill all the voids between the aggregates will be difficult to place and will produce rough, honeycombed surfaces and porous concrete. A mixture with an excess of cement paste will be easy to place and will produce a smooth surface; however, the resulting concrete is likely to shrink more and be uneconomical.

A properly designed concrete mixture will possess the desired workability for the fresh concrete and the required durability and strength for the hardened concrete. Typically, a mix is about 10 to 15 percent cement, 60 to 75 percent aggregate and 15 to 20 percent water. Entrained air in many concrete mixes may also take up another 5 to 8 percent Portland cement's chemistry comes to life in the presence of water. Cement and water form a paste that coats each particle of stone and sand. Through a chemical reaction called hydration, the cement paste hardens and gains strength. The character of the concrete is determined by quality of the paste. The strength of the paste, in turn, depends on the ratio of water to cement. The water-cement ratio is the weight of the mixing water divided by the weight of the cement. High-quality concrete is produced by lowering the water-cement ratio as much as possible without sacrificing the workability of fresh concrete. Generally, using less water produces a higher quality concrete provided the concrete is properly placed, consolidated, and cured.

Other constituent ingredients

Clean drinking water is generally suitable for use in concrete. Aggregates have to be chosen carefully. Aggregates comprise 60 to 75 percent of the total volume of concrete. The type and size of the aggregate mixture depends on the thickness and purpose of the final concrete product. Almost any natural water that is drinkable and has no pronounced taste or odor may be used as mixing water for concrete. However, some waters that are not fit for drinking may be suitable for concrete. Excessive impurities in water not only affect setting time and concrete strength, but also may cause efflorescence, staining, corrosion of reinforcement, volume instability, and reduced durability.



Relatively thin building sections demand small coarse aggregate though aggregates up to six inches (150 mm) in diameter have been used in large dams. A continuous gradation of particle sizes is desirable for efficient use of the paste. In addition, aggregates should be clean and free from any dust or matter that might affect the quality of the concrete.

Hydration

Soon after the aggregates, water, and the cement are mixed, the mixture starts to harden. During the chemical reaction called hydration. A node forms on the surface of each cement particle. The node grows and expands until it links up with nodes from other cement particles or adheres to adjacent aggregates. The building up process results in progressive stiffening, hardening, and strength development. Once the concrete is thoroughly mixed and workable it should be placed in forms before the mixture becomes too stiff. During placement in structure the concrete is consolidated to compact it within the forms and to eliminate potential flaws, such as honeycombs and air pockets. Curing with water begins after the exposed surfaces of the concrete have hardened sufficiently to resist marring. Curing ensures the continued hydration of the cement and helps to gain strength of the concrete. Concrete surfaces are cured by sprinkling water, fog, or by using moisture-retaining fabrics such as burlap or cotton mats. Other curing methods prevent evaporation of the water by sealing the surface with plastic or special sprays (curing compounds). The longer the concrete is kept moist, the stronger and more durable it will become. The rate of hardening depends upon the composition and fineness of the cement, the mix proportions, and the moisture and temperature conditions. Most of the hydration and gaining of strength take place within the first month of concrete's life cycle, but hydration continues at a slower rate for many years. Concrete continues to get stronger as it gets older. Generally we should do curing for 21 days with continuous water wetting.

Bulking of Sand

The presence of moisture in sand increases the volume of sand. This is due to the fact that moisture causes film of water around sand particles which results in the increase of volume of sand. For a moisture content about 5 to 8 per cent, this increase of volume may be as much as 20 to 40 per cent, depending upon the grading of sand. The finer the material, the more will be the increase in volume for a given moisture content. This phenomenon is known as the bulking of sand

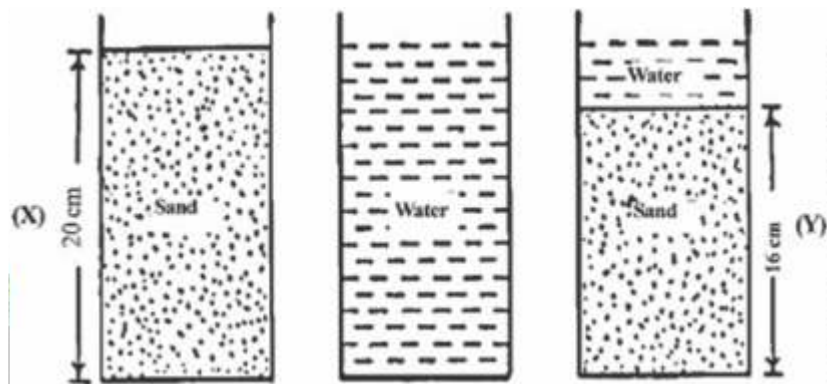

Bulking of Sand

When moisture content is increased by adding more water, the sand particles pack near each other and the amount of bulking of sand is decreased. Thus the dry sand and the sand completely flooded with water have practically the same volume.

A very simple test, may be carried out to decide the percentage of bulking of sand.





Following procedure is adopted

- A container is taken and it is filled two-third with the sample of sand to be tested.
- Height is measured, say it is 20 cm (h_1).
- Sand is taken out of container. Care should be taken to see that there is no loss of sand during this transaction.
- Container is filled with water
- The sand is then slowly dropped in the container and it is thoroughly stirred by means of a rod.
- The height of sand is measured say it is 16 cm (h_2).

Then, percentage of Bulking of sand = $[(h_1 - h_2) / h_2] * 100 = [(20 - 16) / 16] * 100 = 25 \%$



Functions and requirements of concrete ingredients

Functions of cement	
	<ul style="list-style-type: none"> ○ It fills up the voids in the fine and coarse aggregates. ○ Make the concrete impermeable. ○ It provides strength to concrete on setting and hardening. ○ It binds the aggregates into a solid mass by virtue of its setting. ○ Hardens when mixed with water.
Functions of sand	
	<ul style="list-style-type: none"> ○ Sand fills the voids existing in the coarse aggregates. ○ It reduces shrinkage of concrete. ○ Sand helps in reducing the cost of concrete because it is a filler material.
Function of Coarse aggregate	
	<ul style="list-style-type: none"> ○ It makes solid and hard mass of concrete with cement and sand. ○ It reduces the cost of concrete, since it occupies more volume. ○ It increases the strength of the concrete.
Function of Water	
	<ul style="list-style-type: none"> ○ Water wets the surface of aggregates ○ It facilitates the spreading of cement over the aggregates and makes the mix workable. ○ It initiates the hydration process of the cement with sand and aggregates subsequently starts the setting and hardening process ○ It controls the heat generated by the hydration process of the cement



Grading of Aggregates

Grading of aggregate means particle size distribution of the aggregate. If all the particles of an aggregate were, of one size, more voids will be left in the aggregate mass. On the other hand an aggregate having particles of varying sizes will exhibit smaller voids. Principle of grading is that the smaller size particles fill up the voids left in larger size particles. By adopting proper percentages of various sized aggregate, composite aggregate mix can be developed which will be thoroughly graded. Properly graded aggregate produces dense concrete and needs smaller quantities of fine aggregate and cement. The grading of aggregate is expressed in terms of percentages by weight retained on a series of sieves 80mm, 40mm, 20mm, 10mm, 4.75mm

2.36 mm, 1.18mm, 600 micro, 300 mic and 150micare used for fine aggregate.

Gradation has an important effect on the workability and characteristics of fresh and hardened concrete. Gradation of aggregates is most important to produce workable concrete. A well graded concrete contains minimum voids to be filled by the cement paste. This means less quantity of cement and water which further means increased economy, higher strength, lower shrinkage and greater durability. Grading of fine aggregate has much effect on workability of concrete than grading of coarse aggregate. It is seen that very coarse sand or very fine sand is not good for concrete making.

Water-Cement Ratio

Water reacts, with cement chemically and cause setting and hardening of concrete. It is found theoretically that water required is about 0.50 to 0.60 time the- weight of cement.

- Minimum quantity of water should be used to reasonable degree of workability
- Water - Cement - ratio for structures which are exposed to weather should be carefully decided. For instance, for structures which are regularly wetting and drying, water cement ratio by weight should be 0.45 and 0.55 for thin sections and mass concrete respectively. For structures which are continuously under water, the water cement ratio by weight should be 0.55 and 0.65 for thin sections and mass concrete respectively.
- A thumb rule for ordinarily concrete given below assuming the materials are non-absorbent and dry may be adopted. Weight of water = 28% of the weight of the cement + 4% of the weight of total aggregates.



Preparation of Cement Concrete

Materials of concrete should be mixed thoroughly so that there is uniform distribution of materials in the mass of concrete. Also the mixing should ensure that cement paste completely covers the surface of aggregate. Mixing can be done either by hand or by machine.

Hand Mixing



For hand mixing, the materials are stacked on a water tight platform, which may be either of wood, bricks or steel. The materials should be thoroughly mixed, at least three times, in dry condition before water is added. The prepared mix should be consumed in 30 minutes after adding water. Mixing by hand is allowed in case of small works or unimportant works. Where small quantity be adopted, it is advisable to use 10 percent more cement than specified.

Determine how much of each ingredient you will require to prepare a certain amount of concrete and then proceed as follows



	<ul style="list-style-type: none"> ◦ Pour the sand on to the mixing area and spread it evenly.
	<ul style="list-style-type: none"> ◦ Spread the cement evenly over the sand.
	<ul style="list-style-type: none"> ◦ Mix the cement and sand well, stirring with a shovel, until you obtain a uniform colour; spread this mixture evenly over the mixing area.
	<ul style="list-style-type: none"> ◦ Wet the gravel and spread it evenly over the mixture.
	<ul style="list-style-type: none"> ◦ Mix thoroughly together to obtain a homogeneous mixture.
	<ul style="list-style-type: none"> ◦ Rake into a pile and form a hollow in the middle of the mixture.
	<ul style="list-style-type: none"> ◦ From the previously measured volume, slowly add water in the centre and progressively moisten the mixture.
	<ul style="list-style-type: none"> ◦ Shovel back and forth, mixing thoroughly until you obtain concrete of uniform plastic consistency.

Cement Concrete Preparation and its use

Machine Mixing

Machine mixing is carried out by batch mixers or by continuous mixers. Batch type mixers are mostly adopted. Water should enter the mixer at the same time, or before the other materials are placed. The mixing time should be at least one minute and preferably two minutes. The concrete discharged by the mixer should be consumed within 30 minutes. The mixer should be cleaned well after use. This type of mixing is more efficient.



Figure preparing concrete with machine

Consolidation or Compaction of Concrete

The object of consolidation of concrete is to eliminate air bubbles and thus to obtain maximum density of concrete. An intimate contact between concrete and reinforcement is ensured by proper consolidation. The process of consolidation of concrete can be done with the hand or with the help of vibrators.

1. Hand Consolidation

It is done with the help of steel tamping rods or timber screeds. Narrow and deep-members are compacted with tamping rods. The slabs and floors are tamped with the help of screeds. Compaction should be done in layers of 300 mm for mass concrete and 150 mm for reinforced concrete.

2. Mechanical Compaction

Mechanical compaction of concrete in the formwork is carried out using mechanical devices called vibrators. The advantages of using vibrators are,

- It is possible to make a harsh and stiff concrete mix.
- It is possible to improve the quality of concrete.
- It is possible to deposit concrete in small openings and in places where it will be difficult to deposit by hand methods.



Curing of Concrete

Curing is the operation by which moist conditions are maintained on finished concrete surface to promote continued hydration of cement. If proper curing is not done, concrete will not acquire its full intended strength. Moreover, shrinkage cracks will develop in the concrete. Curing also brings improvement in durability, impermeability, wear and weather resisting qualities. There are several methods of curing. Adoption of specific method depends upon the nature of work and the climatic conditions.



Properties of Cement Concrete

Cement concrete possesses the following important properties.

- It has a high compressive strength.
- It is free from corrosion and there is no appreciable effect of atmospheric agents on it.
- It hardens with age and the process of hardening continues for a long time after the concrete has attained sufficient strength.
- It is proved to be more economical than steel
- It binds rapidly with steel and as it is weak in tension. Steel reinforcement is placed in cement concrete at suitable places to take up the tensile stresses. This is termed as "Reinforced cement concrete or simply "R.C.C."
- Due to non absorption of water on the surface it gets the property of shrinkage. If curing is not done shrinkage crack will occur.
- It has a tendency to be porous. This is due to the presence of voids which are formed during and after its placing. It forms a hard surface, capable of resistant of abrasion.



Uses of Concrete

Concrete is used for a variety of purposes like foundations for masonry works, terrace roofs floors, walls, dams, bridges, retaining walls etc. For most of these purposes it is superior to masonry in durability, strength and economy.



The forms of concrete

Concrete is produced in four basic forms, each with unique applications and properties.

- **Ready mixed concrete** -This is batched at local plants for delivery in the familiar trucks with revolving drums.
- **Pre-cast concrete** - This is cast in a factory setting. These products have benefit of high quality control achievable at a production plant. Precast products range from concrete bricks and paving stones to bridge girders, structural components, and panels for cladding.
- **Concrete masonry blocks**- This is manufactured concrete, may be best known for its conventional 8 x 8 x 16 - inch block. Today's masonry units can be molded into different shapes, configurations, colours, and textures to serve an infinite spectrum of building applications and architectural needs.

Type of concrete

The strength of the concrete depends on mix proportions and should suit the work being done. Different applications require different strengths of concrete. Three different strength categories with typical applications are outlined below

- 1) High strength concrete (M 20, M25)

High strength concrete should be used for suspended structural beams and slabs, precast items (stairs) and heavy-duty floors.



2) Medium strength concrete (M 15)













Medium strength concrete is suitable for reinforced foundations and slabs, light duty house floors, paths, steps, driveways and garage doors.

3) Low strength concrete (M 10)

Low strength concrete is suitable for unreinforced foundations for houses and freestanding walls.

Mixing proportion of concrete

Concrete Type	Proportion of Cement	Proportion of Sand	Proportion of Aggregates
M 10	1	3	6
M 15	1	2	4
M 20	1	1.5	3
M 25	1	1	2

Concrete type	Proportion of cement	Proportion of Sand	Proportion of Aggregates
M 10			
M 15			
M 20			
M 25			



Effect of aging

Basically if all rules and regulations for concreting are properly followed, concrete gains strength by aging. However, the rate of increase in strength decreases with time.

Do and Do Not Boxes

Dos:

- Always calculate exactly how much finished concrete is required for the job to do and ascertain how much cement sand, coarse aggregate and water will be required

Why?

Even a good guess can go wrong. While guessing the amount of material required it can happen that you order too much, resulting into unnecessary expenses. It might also happen that you order too less and organizing immediately the remaining material might prove to be difficult or even impossible, resulting into unnecessary expenses and loss of quality.

- Use always-clean sand and aggregates for concrete.

Why?

Contaminated sand and aggregate which contains roots, leaves, plastic parts, saw dust, animal and human excreta etc. will not bind with cement, hence it weakens the concrete. Also sand and aggregate with high percentage of clay or silt will weaken the concrete because the clay or silt contains too many fines that needs to be covered by cement for proper binding, hence, the concrete becomes weak.

- Always use fresh and lump free cement for concrete

Why?

Old cement loses its strength. E.g. cement that has been stored for about 6 months loses 30% strength than fresh cement. For good concrete work, strength is important as it influences the overall building quality.

- Always mix the dry ingredients (sand & cement) together before adding water.



Why?

Wet sand particles have the tendency to stick together and therefore it hinders the cement to cover them. This results in a non uniform mix that reduce the concrete quality, because each sand and aggregate particle should ideally be fully covered with cement.

Further, adding water together with sand, aggregate and cement in one go makes mixing concrete extremely difficult for the labourers.

- Always protect the concrete-mixing place from wind, rain and sunshine.

Why?

Wind and sunshine makes the water evaporates from the concrete and accelerate the hardening process before it puts into use. This makes the concrete unfit for any purpose. Rain adds water to the concrete which becomes too wet, resulting in less strength.

- Use the concrete mix within a maximum of 1 hr. after wet mixing

Why?

Concrete which was mixed more than 1 hour before in which the hydration process of cement started and if you do remix, it destroys the bond between cement and sand/aggregates. This bond cannot regain its strength by simply adding fresh water to the concrete.

- Use always-proper quantity measuring boxes.

Why?

Using empty non specified boxes may not always ensure that the correct amount of raw material is being added. This inaccuracy could lead to a leaner mix reduce the concrete quality and add extra costs.

- Always make a final check of the formwork before placing the concrete into the form.

Why?

During placing of the reinforcement some supporting poles or bracing might have been dislocated. If new concrete is poured the frame work like, side shuttering or even slab shuttering might collapse because of weight. This is the worst- scenario happening too often here and there, sometimes even cause death of the people.



Don'ts

✘ Do not start concrete work if the outside temperature is above 40 degree Celsius.

Why?

When the temperature is above 40 degree celsius water evaporate from the freshly prepared concrete very fast, causing serious shrinkage cracks and hinders the process of hardening of the concrete. This will finally weaken the strength of the concrete.

However, if it is unavoidable to stop concreting work, then the following precautions should be taken:

- Cooling down the aggregates by water sprinkling
- Providing a shade at the casting side
- Placing immediately plastic sheet on the casted concrete

Form work

Most structural concrete is made by casting concrete into previously made boxes that are called forms or shuttering. Usually wall, column, beam and slab forms are built by joining wooden boards' edge on edge. Sometimes plywood may be nailed, for tighter and more wrap resistant. In certain cases metal forms are used, e.g. when a large number of equal structural members (pre-cast elements) have to be erected or when the parts should be very exact in measurements.





The most suitable material for formwork is wood, in particular boards, rails, batten and planks. All this timber is available in various qualities and dimensions. Hardwood should not be used for parts where nailing is necessary. Boards of less quality and boards of rough surface do not last very long for shuttering work. Using plastic or metal sheets are economical and high qualitative.

All form work material (planks, boards, steel etc.) and elements formwork (moulds) are sprinkled with water before placing concrete. After striking or dismantling, the formwork is cleaned and eventually oiled as well as properly stored and protected from sun and rain. This will guarantee the use of frame work repetitively.

Formwork for pre-cast products like cover slabs, fence posts, well and culvert rings, and element of formwork for standard structures like stand posts should be made of quality timber or steel. The use of GI sheets as additional reinforcement for timber formwork is very suitable because nailing of sideboards or batten is still possible.

Removal of the formwork

Formwork should be left in place until the concrete is hardened enough to hold its own weight and any other weight. The surface must be hard enough to remain unmarked while stripping the forms.

Under ordinary circumstances, formwork for various types for construction may be removed after intervals as follows:

Side forms on beams, lintels, walls, columns	1 to 2 days
Slabs, lintels/beams with clear span 3 m and below, clear span 3-6m, clear span more than 6m	8 to 14 days, 16 to 14 days, 24 to 35 days respectively
Cantilever constructions	as long as possible but min. 35 days (because of creeping of the concrete)



Practical Exercises:

Go to a work site and observe the practical process of making Cement Concrete.

Work Book

Go to a work site and observe the practical process of making Cement Concrete and answer the following question.

Q 1: Where concrete is used?

Ans: _____

Q 2: Write the names of concrete ingredients and also describe their functions.

Ans: _____

Q 3: Describe the three important points in hand mixing process of concrete.

Ans: _____

Q 4: What is curing and explain the different methods of curing.

Ans: _____

Q 5: Write mixing proportions of different types of concrete.

Ans: _____

Element 8

Foundations





Learning Element Outcomes

This specific learning outcome will enable you to identify and describe the different type and functions of foundations.

Summary

Foundation is one of the major parts in any structure. We can't imagine the structure without proper foundation. This element gives us primary knowledge of importance of foundation and its types.

Introduction

Every building has two important parts. The one part is below the ground level and another part above the ground level. The structure constructed below the ground level to transmit the total load of the structure safely to the earth is called foundation of the structure.



Objective

- Foundations are constructed to allow the uniform distribution of total load of the building/structure over a larger area.
- The foundations give stability, strength and protection from wind, storm and rain to the structure.
- The foundation gives uniform and equal area for the structure above the ground level.



Types of Foundation

1. Shallow foundation
2. Deep foundation.

1. Shallow foundation

The foundations are provided in ordinary buildings with low depth, up to 1.5 m depth are known as shallow foundation.

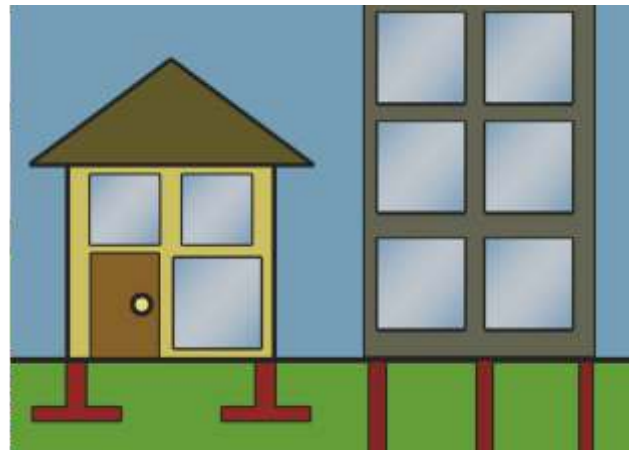
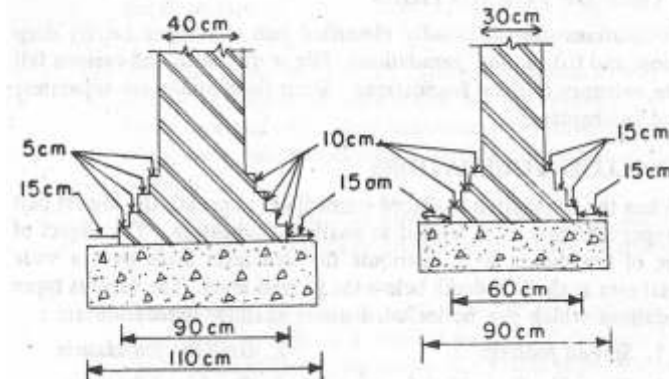
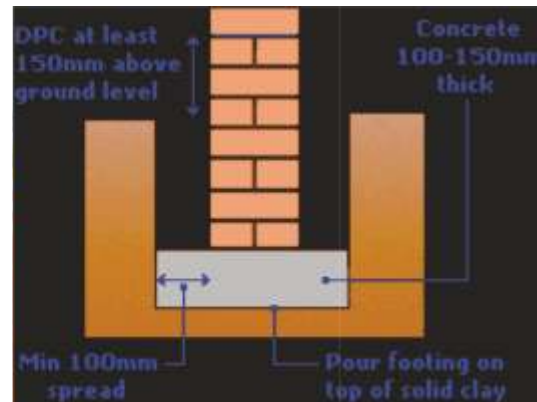

Fig: Shallow foundations of a house versus Deep foundations of a skyscraper

In this element we will learn about column footing and wall/spread footing which are commonly used for structure in MGNREGS works.

Wall Footing (or) Spread Footing: The bottom portion of the wall should have bed concrete with 1:3:6 proportion on the bed concrete. The stone masonry with rough stone should be generally laid as part of the foundation.





Column footing

These foundations are formed for individual concrete (or) Brick Pillar. The base structure is formed in stepped (or) sloped position. Reinforced concrete foundations should be designed for the foundations of heavy weight pillars



Element 9

Superstructure with Stone/ Brick Masonry





Learning Element Outcomes

This specific learning outcome will enable you to identify and describe the most common stone and brick masonry types including their important characteristics and suitability for rural infrastructure works, as well as to identify and describe the required tools used for simple masonry works

Summary

Structure built above the ground is called superstructure. Superstructure can be made with mud, wood, stone and masonry. To built superstructure we need tools. In this learning unit, stone masonry and brick masonry are described and also introduced tools to be used for masonry works.

Stone Masonry

If construction is carried out using stones with cement or lime mortar, it is known as stone masonry. Key features of stones to be used in the stone masonry are given below:

- The compressive strength of common types of stones shall be 300 Kg. / Sq. cm and the percentage of water absorption shall generally not exceed not more than 5%.
- Stones obtained from quarries shall be used for masonry works.
- They should not have defects like cavities, cracks, flaws, sand holes.
- Stones with round surface shall not be used





Dressing

Each stone shall be hammer dressed on the face, the sides and the bottom.

Hammer dressing shall enable the stones to be laid close to neighboring stones.

Mortar

The cement mortar shall be used as per the requirement of the structure.

Normally cement mortar (1:5) or (1:6) mix is to be used.

Points to be considered in the construction of stone masonry

- The stones used should conform to the required specifications.
- The stones should be well watered before use.
- The dressing of stones should be properly done.
- Proper bond with sufficient number of long stones should be provided in construction. These long stones are called bond stone.
- Good quality of mortar should be used in construction.
- Stone work should be raised uniformly.
- In the stone work, small pieces of stone and chips should not be used.
- The stone work should be carried out as per line and level. Thread and plum bob should be used to maintain level to perfect vertical.



Curing

- Masonry work in cement mortar shall be kept constantly moist on all faces for a minimum period of seven days.
- In case of masonry with lime mortar, curing shall commence two days after construction of masonry and shall be continued at least for 7 days.



Stone masonry may be broadly classified into the following three types:

The stone masonry in which either undressed or roughly dressed stone are laid in a suitable mortar is called rubble masonry. In this masonry the joints are not of uniform thickness. Rubble masonry is further sub-divided into the following type

A. Random rubble masonry: The rubble masonry in which either undressed or hammer dressed stones are used is called random rubble masonry. Further random rubble masonry is also divided into the following two types:

1) Un-coursed random rubble masonry: The random rubble masonry in which stones are laid without forming courses is known as un-coursed random rubble masonry. This is the roughest and cheapest type of masonry and is of varying appearance. The stones used in this masonry are of different sizes and shapes. Before laying, all projecting corners of stones are slightly knocked off. Vertical joints are not plumbed, joints are filled and flushed. Large stones are used at corners and at junctions to increase their strength. One “through stone” (bond stone) is used for every square meter of the face area for joining faces and backing.

Suitability: Used for construction of walls of low height in case of ordinary buildings.

2) Coursed random rubble masonry: The coursed random rubble masonry in which stones are laid in layers of equal height is called coursed random rubble masonry. In this masonry, the stones are laid in somewhat level courses. Headers of one coursed height are placed at certain intervals. The stones are hammer dressed.



Suitability: Used for construction of residential buildings, go downs, boundary walls etc.



B) Dry rubble masonry: The dry rubble masonry in which stones are laid without using any mortar is called dry rubble masonry or sometimes shortly as dry stones masonry. It is an ordinary masonry and is recommended for constructing walls of height not more than 3m.



Tools Used in Stone Masonry

- Trowel - To lift and spread mortar.
- Plumb bob - To check the verticality wall.
- Spirit level - To check the horizontality of the surfaces.
- Hammer - For rough dressing of stones.
- Chisels - To dress stones.
- Line and pins - To maintain the alignment of the progress

Brick Masonry

The craft of the bricklayer is concerned with embedding bricks in mortar and suitably arranging them so that the mass, called brickwork conforms to certain requirements such as strength and appearance. Strength depends on the bond.

Selection of bricks

Where good and bad quality of bricks are supplied in one truck load, it is advisable to select first, all the good quality out of the supplied bricks. This is especially important where bricks are used for constructing of load bearing walls. And well burnt bricks (not under burnt or over burnt) should be used for construction of bricks masonry.





Brick cuttings

The mason needs to check each brick (sound test with a hammer) and must reject bricks that are faulty. In order to avoid too much wastage, only good bricks (without crack) should be cut.

The correct size to be cut should be marked on the brick. A brick-cutting hammer is the most appropriate tool to cut a brick, avoid cutting bricks with a trowel. The trowel is not meant for this work.

Brick soaking

Before a brick is placed for masonry work, it needs to be thoroughly soaked in water. Dipping the brick into a water bucket at least should be done just before placing it in the wall. Essentially, the soaking of bricks is done for two reasons:

Dust

The surface of the brick is always covered with lot of dust, sometimes-even dirt. If this dust or dirt layer is not properly removed, the binding between the brick and the mortar will not be effective, hence the entire brick masonry would be weakened.

Soakage of Water by Brick

Further, a dry and porous brick will immediately consume the water from the mortar which is required for ensuring the proper hardening and controlled setting of the cement. If the cement does not have enough moisture to ensure a proper hydration process the final mortar strength will be considerably reduced and the masonry wall gets weakened.

Maximum brick wall height per day

The maximum construction of brick wall height per day should not exceed more than 12 to

14 layers. Because the added weight by each new brick layer (course) needs to be carried by the mortar. The mortar bottom layer however needs time to harden and to be able to carry load. If the mortar buckles or yields there will be possibility of collapse on the same day or the masonry weakens and develop cracks later.



Curing

A brick wall needs to be cured for at least 7 days. Several times a day, water needs to be poured over the brick wall. The walls are mostly exposed to wind and sunshine and hence water (moisture) in the wall will be dried out very quick. However, to gain the appropriate bearing strength, the mortar needs certain moisture content for hardening. Therefore, the brick masonry needs regular curing for at least 7 days. There should not be any long gaps between wetting. We have to ensure the masonry is always wet.

Pointing

Pointing is done to stone masonry/brick masonry when we don't do plastering. The main reasons for pointing the surface of block or brickwork joints are to increase its weather resistance and to give a neat looking finish to the work.



Pointing can be carried out using ordinary mortar in which the bricks are bedded.

Pointing work is generally done with 1:2 or 1:3 cement mortar. The joints must be raked out to the depth of about 1 to 1.5 cm, brushed, washed and filled with the cement mortar.

Bond





The arrangement of bricks in successive courses to tie the brick work together both longitudinally and transversely. The arrangement is usually designed to ensure that no vertical joint of one course is exactly over other in the next course above or below it.





Types of Bond

<p>Stretcher bond: Bricks placed with its length facing outside.</p>	
<p>Header bond: Bricks placed with its Width facing outside.</p>	
<p>English bond: Bricks in one layer length facing outside (Stretcher) and the next layer width facing outside (Header)</p>	
<p>Flemish bond: Bricks in one layer with length facing outside (Stretcher) and the same layer next bricks placed with width facing outside (Header)</p>	



Tools	Used For
	<ul style="list-style-type: none"> ○ To pick up mortar from a basket. ○ To place and spread the mortar into a brick, or set of bricks ○ To secure a brick into the mortar by tapping
<p data-bbox="280 653 383 678">Trowels</p> 	<p data-bbox="800 680 1346 1129">Straightedges act as extensors to mason's levels: they are used when levels are shorter than the area that needs to be measured or assessed. The middle section of the top of the straightedge must be horizontally parallel to the bottom section. Widths of these tools range from 1 1/8 to 1 1/2 inches; it can be as long as 16 feet. Masonry tools are as important as the skill of a mason. They are widely available in hardware stores and supply outlets. Due to the nature and scope of masonry work, they are built with durable materials to withstand heavy loads and long use.</p>
<p data-bbox="280 1089 440 1115">Straightedge</p> 	<ul style="list-style-type: none"> ○ Chisel is used to cut bricks into specific sizes. ○ Masonry hammer has a square face on one end for breaking; it has a sharp edge on the other for cutting. They are used to split bricks or Stone.
<p data-bbox="280 1425 521 1451">Chisel and Hammer</p> 	<ul style="list-style-type: none"> ○ L-Squares are used while constructing and measuring right angles and for corner layouts. They are usually made of metal for durability. ○ These are also called L scale.



Squares	
	A mason's level is used while establishing vertical or plumb lines and horizontal or level lines. They are typically made of wood,
	metal, or a combination of both. It come equipped with either single or double vials.
Spirit Level	The latter is preferred more by masons since it can be used for both horizontal and vertical measurements.
	<ul style="list-style-type: none"> □ A plumb-bob is a weight, usually with a pointed tip on the bottom, which is suspended from a string and used as a vertical reference line, or plumb-line.
Plumb bob	

Points to be observed in the construction of Brick masonry

- The bricks used in masonry work should be of sound, hard and well burnt with uniform size, shape and colour.
- The bricks should be thoroughly soaked in clear water before use to reduce their tendency of suction of water from wet mortar.
- Only specified mortar of a good quality should be used.
- No brick - bats should be used except in the corner or end point.
- The progress of work in raising masonry should be in uniform layers at one level.
- Brickwork should be ensured that a proper bond is maintained throughout the work.
- The bricks should be laid on a bed level of mortar. The frog (Groove on top of the brick) in the brick should be at the top and filled with mortar to ensure proper key between layers.



- Scaffolding should be made for construction to do in heights.
- All the course should be laid truly horizontal and all the vertical joints should be truly vertical. The verticality should be checked with plumb bob.
- All the finished masonry work should be kept wet for at least seven days.
- Curing for two weeks shall be done for cement mortar.

Thickness of brick wall

The following thickness are generally maintained for different purpose.

- 4" thick (10 cm)
- 9" thick (23 cm)
- 14" thick (35 cm)

Note:

The 4" thick wall are used as partition like toilets, balconies etc.

The 9" thick wall are used as wall between rooms in framed structured building.

The 14" thick walls are used for load bearing walls in houses, office building in 1+1 floor.



Work book

Q 1: Visit the building in the campus and find out the type of masonry and bonds used. Interact with a mason and list out the tools which s/he is using.

Ans: _____

Q 2: What are the important points to be considered in stone masonry work?

Ans: _____

Q 3: Describe the Dry rubble masonry and random rubble masonry.

Ans: _____

Q 4: Write name of tools used in stone masonry.

Ans: _____

Q 5: How many days minimum curing must be done for brick masonry wall?

Ans: _____

Q 6: Explain the different types of bonds used in brick masonry construction.

Ans: _____

Q 7: What are the points to be kept in mind during construction of Brick masonry?

Ans: _____

Element 10

Occupational Safety and Health standards for Workers on Site





Learning Element Outcomes

This specific learning outcome will enable you to list out and describe certain occupational safety and health standards to be followed while executing work under MGNREGS.

Summary

In this Learning Element contain occupational safety and health standards are explained.

Introduction

The main reasons for construction related accidents are carelessness, technical faults, inappropriate use of tools, wrong action of workers, abuse of alcohol, and most importantly no proper awareness about potential sources of accidents.

A construction site is the place where people come to work together mainly to earn livelihood to support their families. The place where people come together for earning livelihood must be safe; no economical consideration justifies an accident. It is always a great tragedy for a family, if accident happens with the reason of a preventable measure.

By knowing the sources of potential and predictable accidents in advance we can prevent them. It is the duty of a construction supervisor to know the potential sources of accidents and to prevent them as far as possible.

Guidelines to Prevent Accidents

- Only professionals should make electrical installations.
- No electrical wires would be allowed to lie free on the ground.
- No person without a valid license should be allowed to drive a tractor, truck or any other vehicle at the construction site.
- No fire shall be made at the construction site.
- No ladder with structural default should be used. The supervisor is responsible to order for its repair and maintenance.
- Erect ladders in positions where people do not have to walk underneath them.
- When going up and down a ladder, always face the ladder.
- Do not leave discarded timber with nails facing out. Shuttering timber must always be collected and stored in one place.
- Special care needs to be taken for scaffolding work. The scaffolding material needs to be strong and well-fixed.



Storage

- Storage of explosives and health hazardous materials should not be allowed at the construction site.
- Bricks or blocks shall not be piled up higher than 1.5 m at the storage/construction site.
- Material such as steel bars, timber, sand and cement should be stored in such a way that access to the construction site is not blocked.

Conduct

- No alcohol consumption should be allowed at the work site.

Working Conditions

- For night work, proper lighting arrangements should be made available at work site.
- For stone cutting and chiseling works, the workers need to be instructed how to avoid eye injuries.

Cleanliness, hygiene & resting place

- The work site should be kept clean.
- An official resting-place protected from rain and sun-shine should be designated at site.
- Clean drinking water should be provided at the resting-place as well as at the working place.
- A care giving worker should be engaged at work site if there are more than five children of age less than six years of labourers are at work site.

Safety and health on site

Safety risks are relatively limited on community- executed rural infrastructure works because work operations are simple and few machines are involved. Nevertheless, it is important to ensure that essential safety and health measures are taken.



Essential safety measure

- First aid kit to be on site.
- Protective goggles for stone cutting, chiseling, grinding and welding.
- Gloves should be used for handling chemicals, waste and other hazardous material.
- Face masks when working in dust.
- Helmets when working on sites where there is a danger of falling objects, e.g. in deep drains, when digging deep trenches, working in quarries etc.
- The site supervisor should also know where the nearest hospital/ clinic are and where an ambulance for quick transportation can be found. He/she shall know the phone numbers ambulance and fire etc.
- It is also advisable that the site supervisor has first-aid knowledge.
- Training should be given to all on safe working methods.

Special safety measures are required when deep trenches have to be dug, for water or other purposes. Depending on the material (natural soil) and the depth of the trench, shoring has to be done carefully.

Essential health measures

- Sufficient and clean drinking water to be on site.
- No alcoholic drinks during work. Drunken labour should not be allotted the work at work site.



Work book:

1. What are the measures taken for safety?

Ans: _____

2. How do you react when you discover fire at work site?

Ans: _____

3. Explain the solutions to control preventable risks prone to accidents?

Ans: _____



Field Notes:

A series of horizontal dashed lines for writing field notes.



Occupational Safety and Health standards



International Labour Organization
(Joint Initiative with Ministry of Rural Development, Government of India)
India Habitat Centre
Core 4B, 3rd Floor
Lodhi Road
New Delhi 110 003
India